

MANUTENZIONE / MAINTENANCE / WARTUNG

SOSTITUZIONE CARTUCCE E VITONI / CARTRIDGE REPLACEMENT / KARTUSCHEN- UND PATRONENAUSTAUSCH

MISCELATORE LAVABO MONOFORO + MISCELATORE BIDET MONOFORO / ONE-HOLE WASH BASIN MIXER + ONE-HOLE BIDET MIXER / EINLOCH-WASCHTISCHARMATUR + EINLOCH-BIDETARMATUR

• 20 • 20.1090 - 20.1310 - 20.1311 - 20.2210 • 21 • 21.2210 • 22 • 22.1316 - 22.2218 • 33 • 33.1318 - 33.2219

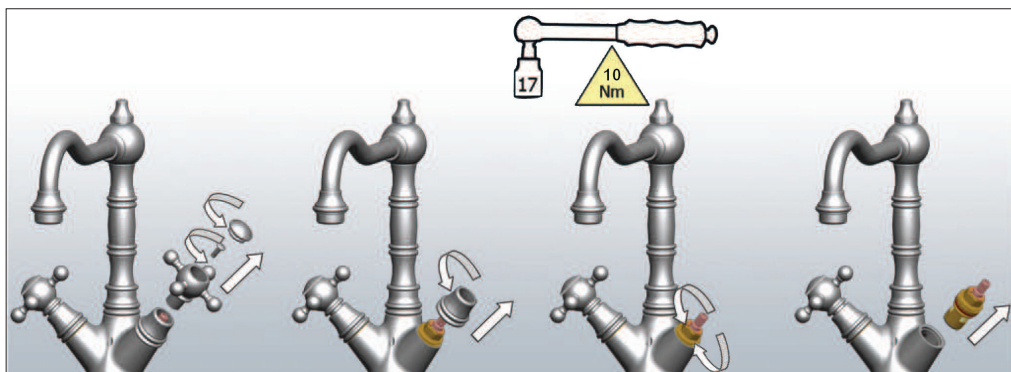

• 22 • 22.1000 • 30 • 30.1000 • 33 • 33.1000

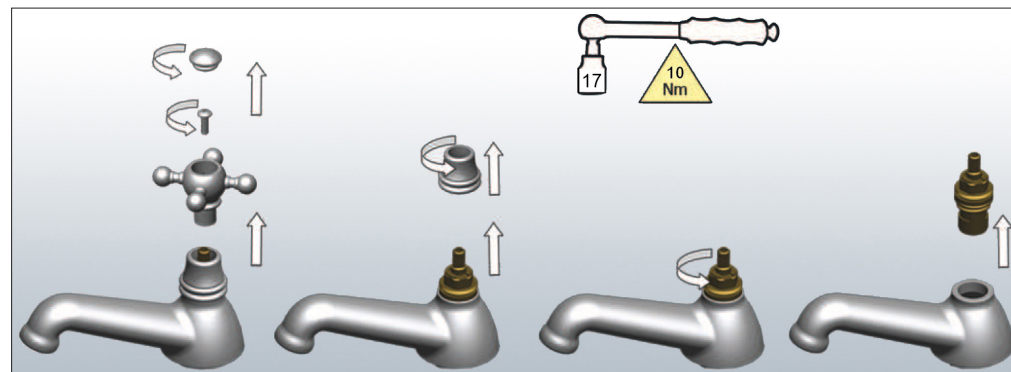

• 30 • 30.1317 - 30.2218

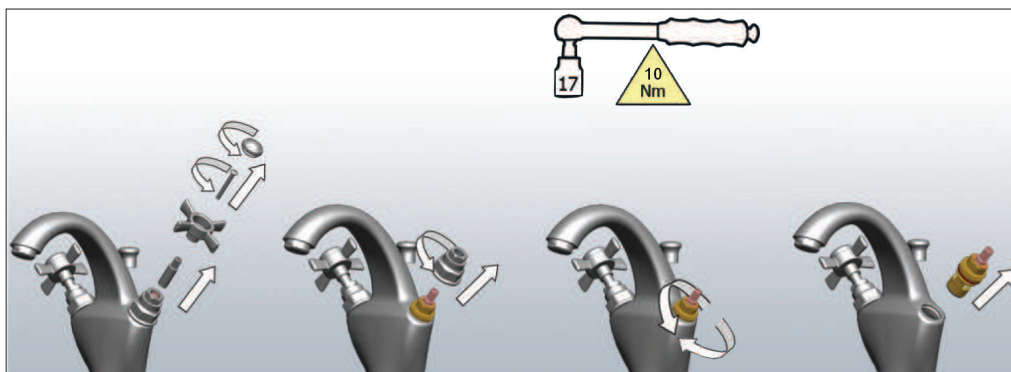

• 39 • 39.1420 - 39.1430 - 39.2402

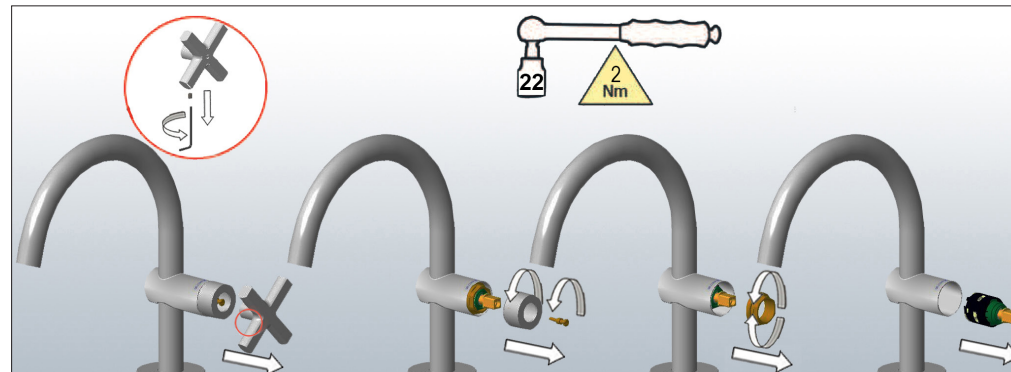

• 39 • 39.1320 - 39.1330 - 39.2102

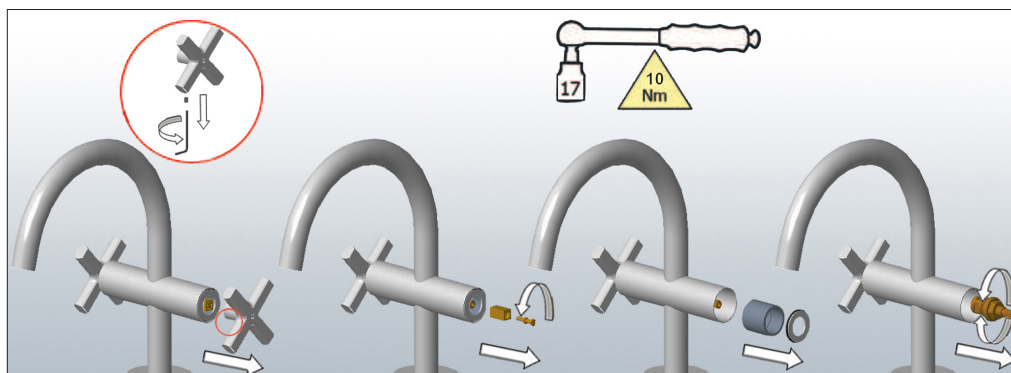

• 44 • 44.1120 - 44.1130 - 44.1140 - 44.2102 • 45 • 45.1120 - 45.1130 - 45.1140 - 45.2102 • 63 • 63.1120 - 63.1130 - 63.1150 - 63.2102 • 67 • 67.1120 - 67.1130 - 67.1150 - 67.2102

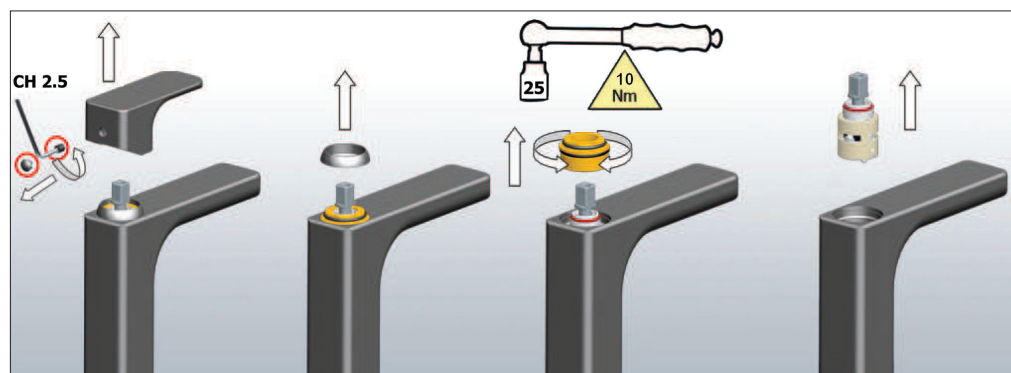

MANUTENZIONE / MAINTENANCE / WARTUNG

SOSTITUZIONE CARTUCCE E VITONI / CARTRIDGE REPLACEMENT / KARTUSCHEN- UND PATRONENAUSTAUSCH

MISCELATORE LAVABO MONOFORO + MISCELATORE BIDET MONOFORO / ONE-HOLE WASH BASIN MIXER + ONE-HOLE BIDET MIXER / EINLOCH-WASCHTISCHARMATUR + EINLOCH-BIDETARMATUR

• 48 • 48.1120 - 48.1130 - 48.1140 - 48.1170 - 48.1180 - 48.1190 - 48.2102 - 48.2122

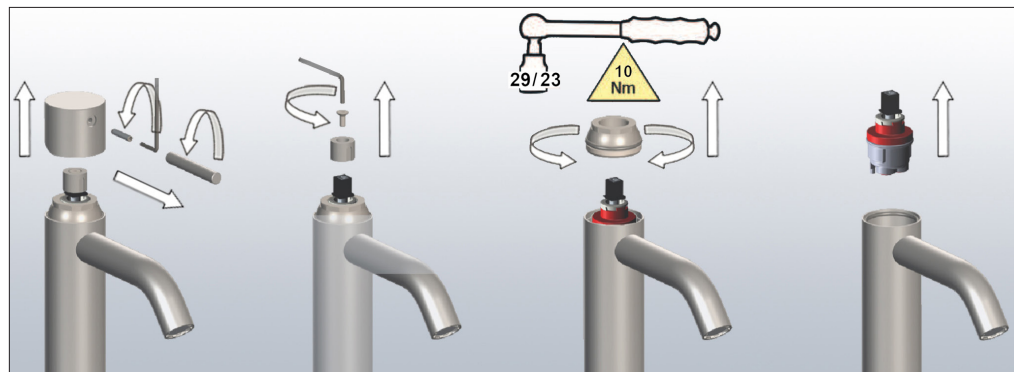

• 46 • 46.1121 - 46.1131 - 46.1141 - 46.2122 • 52 • 52.1110 - 52.1120 - 52.1130 - 52.1140 - 52.2102 • 84 • 84.1121 - 84.1131 - 84.1141 - 84.1172 - 84.1182 - 84.1192 - 84.1101 - 84.2112 - 84.2122

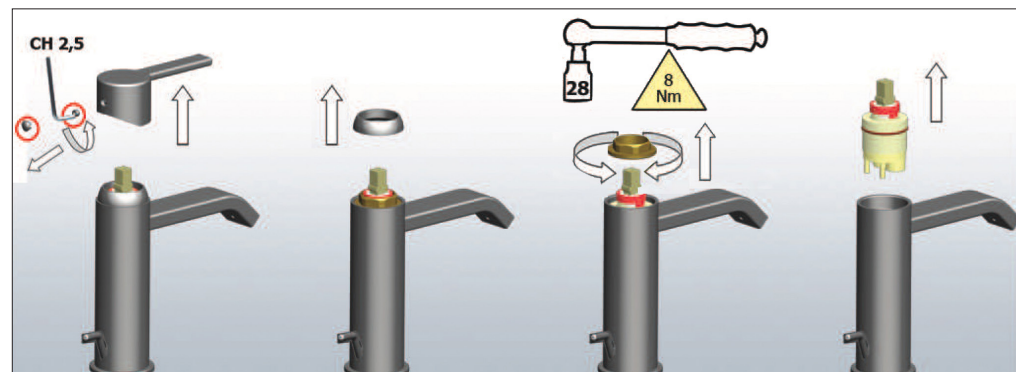

• 58 • 58.1120 - 58.1130 - 58.1140 - 58.1150 - 58.2102

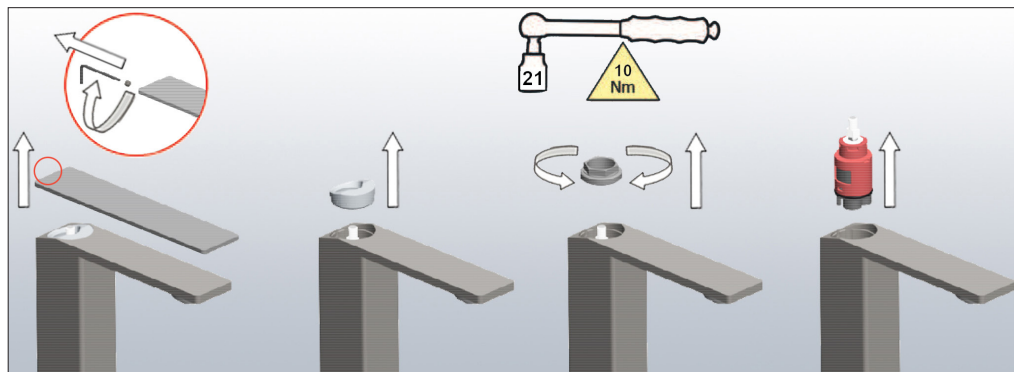

• 59 • 59.1120 - 59.1130 - 59.1140 - 59.1150 - 59.2102

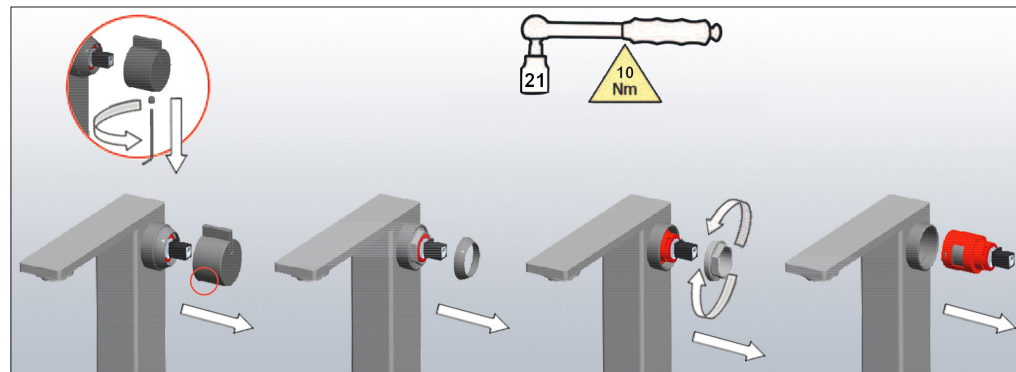

• 68 • 68.1120 - 68.1130 - 68.1150 - 68.2102

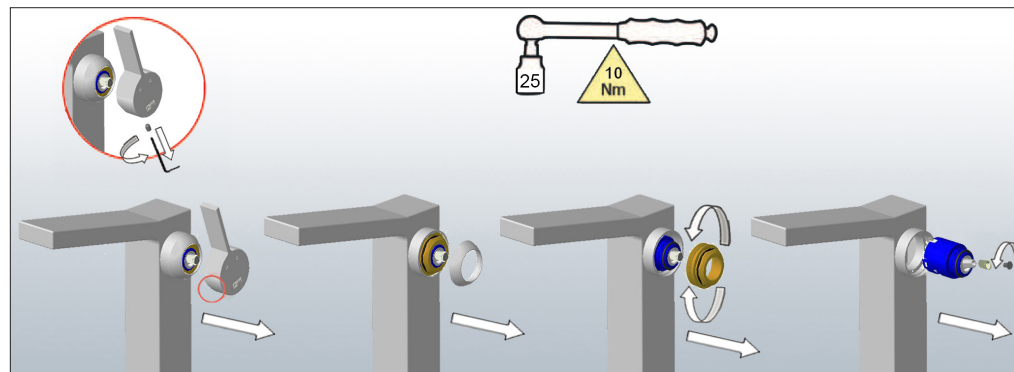

• 70 • 70.1410 - 70.2410 • 70 • 71.1410 • 71 • 71.2410

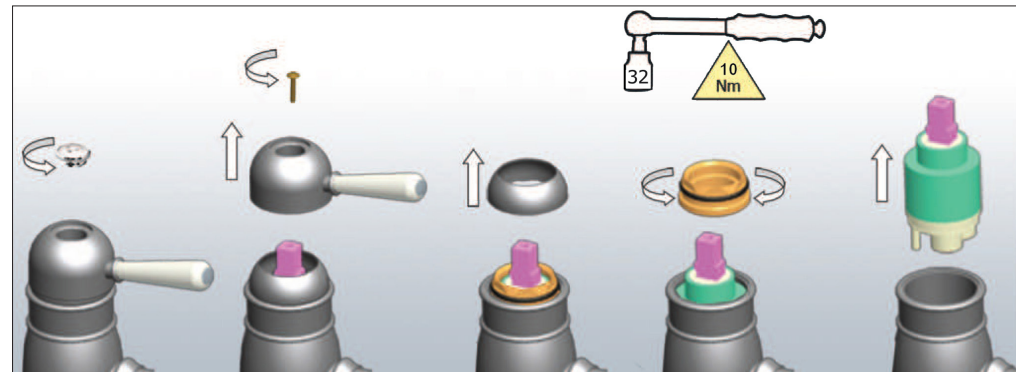

MANUTENZIONE / MAINTENANCE / WARTUNG

SOSTITUZIONE CARTUCCE E VITONI / CARTRIDGE REPLACEMENT / KARTUSCHEN- UND PATRONENAUSTAUSCH

MISCELATORE LAVABO MONOFORO + MISCELATORE BIDET MONOFORO / ONE-HOLE WASH BASIN MIXER + ONE-HOLE BIDET MIXER / EINLOCH-WASCHTISCHARMATUR + EINLOCH-BIDETARMATUR

•77 • 77.1420 - 77.1430 - 77.2402

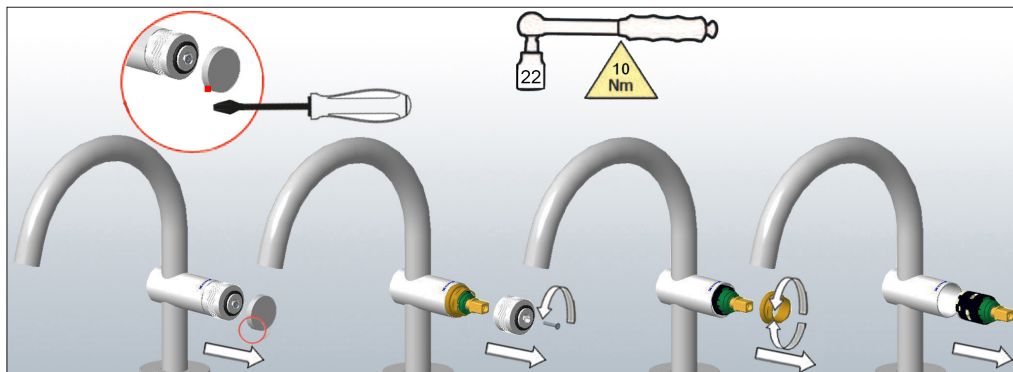

•77 • 77.1320 - 77.1330 - 77.2102

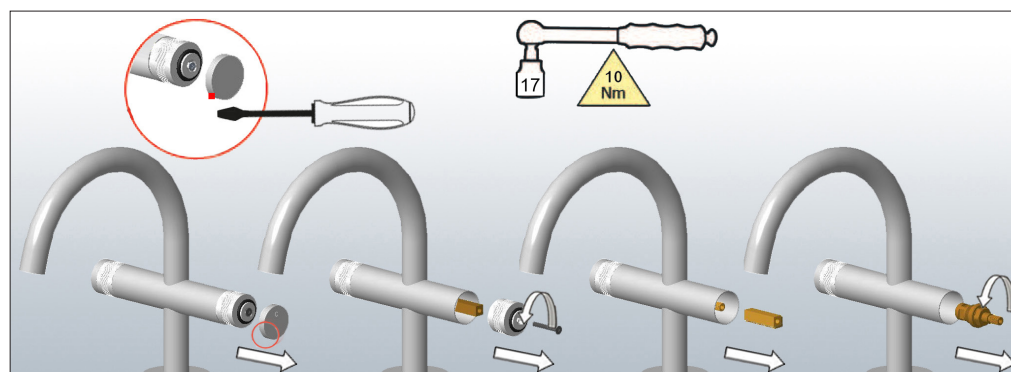

•87 • 87.1520 - 87.1521 - 87.1522 - 87.1523 - 87.1524 - 87.2522

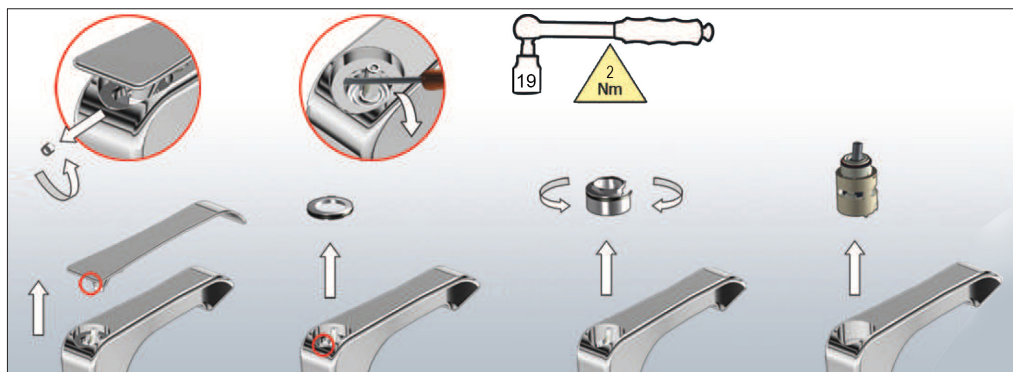

•88 • 88.1525 - 88.1526 - 88.1527 - 88.1528 - 88.1529 - 88.1530 - 88.1531 - 88.1532 - 88.1533 - 88.2522 - 88.2527 - 88.2530 - 88.1531

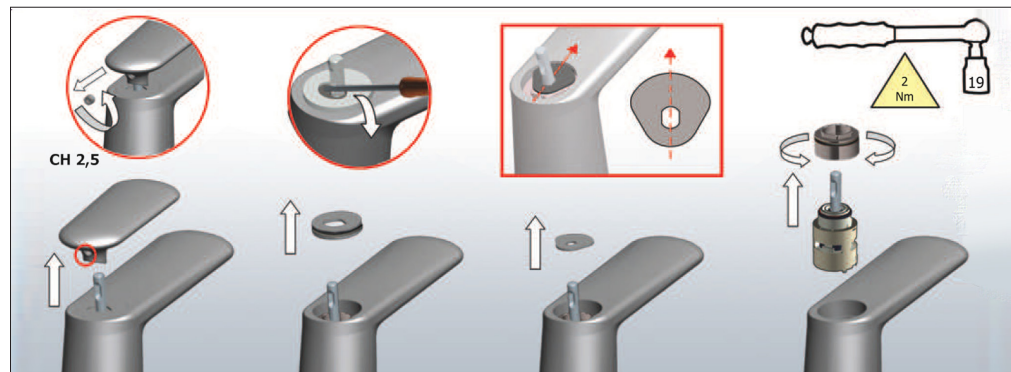

•90 • 90.1120 - 90.1130 - 90.1140 - 90.1150 - 90.2102

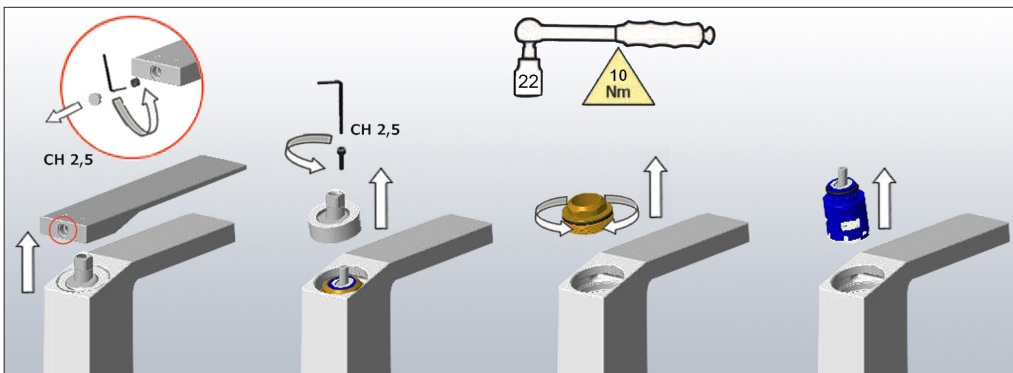

•93 • 93.1120 - 93.1130 - 93.1140 - 93.1150 - 93.2102 •94 • 94.1120 - 94.1130 - 94.2102 •95 • 95.1120 - 95.1130 - 95.1140 - 95.1150 - 93.2102

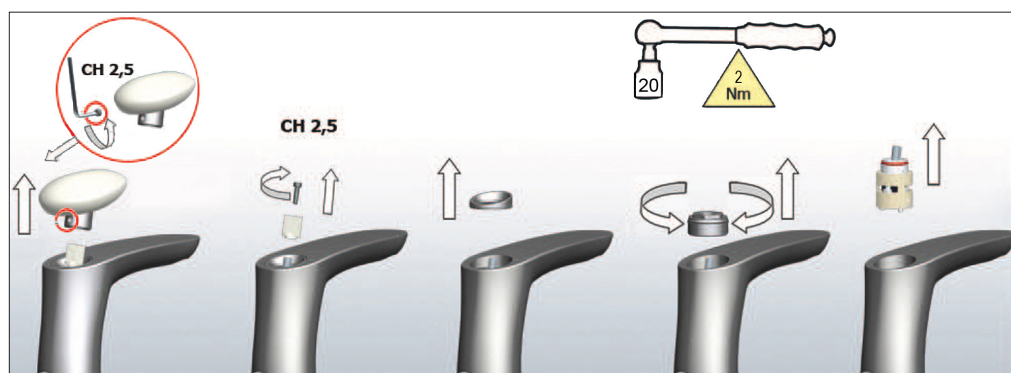

Le informazioni riportate sono redatte al meglio delle conoscenze del fornitore. Il loro carattere è informativo e non costituiscono garanzia.
E' responsabilità dell'utilizzatore attenersi alle condizioni di corretto esercizio. In caso di malfunzionamento si è pregati di rivolgersi direttamente al rivenditore.

Data herein contained are drawn up at the best of the manufacturer's knowledge. They are only given for information purposes and do not constitute any guarantee whatsoever.
It is the user's responsibility to comply with correct operating conditions. In case of malfunction, contact the dealer.

Die angegebenen Informationen wurden mit bestem Wissen des Herstellers verfasst. Die Angaben dienen nur zur Information und stellen keine Garantie dar.
Die Einhaltung der angeführten Hinweise ist Voraussetzung für eine einwandfreie Funktion: Es liegt in der Verantwortung des Benutzers, solche Bedingungen einzuhalten.
Sollten dennoch Probleme auftreten, wenden sie sich bitte direkt an den Sanitärfachhandel.



Fir Italia S.p.A

Via Borgomanero 6,
28010 Vaprio d'Agogna (No) - Italy

+39 0321 996423

firitalia.it

info@firitalia.it